

HOT SMOKE SEAL™

Edge Sealing - Tested and Classified for Fire

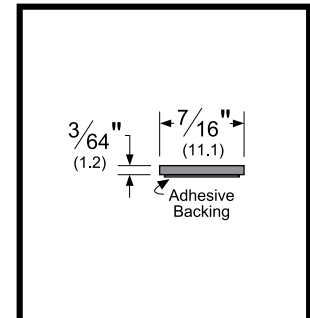

About Edge Seals:

Edge Seals are Category G materials that have demonstrated their ability to assist the door in meeting the positive pressure fire test requirements. Category G materials are necessary for use with Category B Door assemblies. Category G Edge Seals may also need a Category H Smoke Seal for a complete fire and smoke assembly.

About Fire Seals:

Pemko fire seals are tested to the requirement of UL10B, UL10C and BS476. These products carry a Category "G" rating for application to Category "B" door assemblies.

- Adhesive backed intumescent.
- Care must be taken to maintain clearance requirements of NFPA 80.
- Pemko's intumescent edge seal can now be used on a wide range of 20, 45, 90 and 180 minute rated door and frame applications.
- Helps prevent penetration of life threatening hot smoke and hot gasses by expanding and filling the gap between a pair of doors or around the perimeter of the door (depending on if used as meeting stile or door frame application).
- Activation takes place without noxious fumes or smoke being given off.
- Chemically inert.
- Carbon dioxide and erosion-resistant.
- Highly stable.
- Moisture-resistant.
- Can be painted to match door.

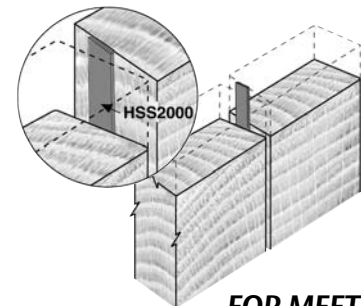
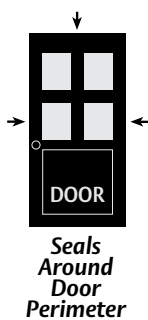

FOR MEETING STILE APPLICATIONS

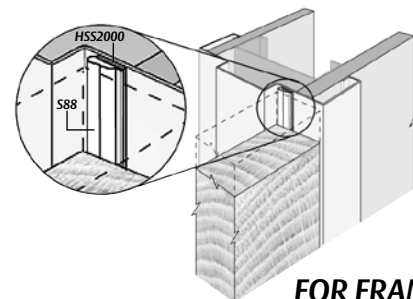

FOR FRAME APPLICATIONS

Product / Available Finishes:

- HSS2000 Graphite
- HSS2000W White/Graphite

Testing/Ratings:



Miscellaneous Fire Door Accessory



Cladding materials for doors and frames intended for application on listed fire door frames used with steel doors rated up to and including 3 h, wood composite doors rated up to and including 1-1/2 h, and wood core fire doors rated up to 20 min without hose stream.

Tools Required:

Sharp knife or scissors.



ASSA ABLOY, the global leader in door opening solutions

UNITED STATES:

MEMPHIS, TN
Ph: 800.824.3018
Fax: 800.243.3656

VENTURA, CA
Ph: 800.283.9988
Fax: 800.283.4050

CANADA:

VANCOUVER, BC
Ph: 877.535.7888
Fax: 877.535.7444

TORONTO, ON
Ph: 866.243.9816
Fax: 866.243.9817

www.pemko.com

Read Before Installation:



Read before installation! Failure to do so may result in improper adhesion.

Storage and shelf life: All adhesive gaskets have a limited shelf life. This product must be used within 6 months of purchase and must be stored between 50°F and 100°F.

Before installing: Thoroughly clean the frame with the enclosed cleansing towelette to remove grease, dust or cleanser build-up. Before installation, wait for frame surface to completely dry (evaporate). Some hospital environments have wax or anti-bacterial cleanser build-up. As an alternative or substitute cleanser, use isopropyl (rubbing) alcohol. Note: Mineral spirits or other petroleum based cleaning products should NOT be used.

Application temperature: If frames are too cold (below 50°F) or too hot (above 100°F) adhesion may be impaired.

When to install:

- Installation should take place after construction is completed, flooring is installed and final cleaning is completed.
- Paint on frame must be cured for at least 5-7 days. Paint cannot be wet under dry surface when gaskets are pressed on. Avoid quick-dry primers, which leave a powdery surface preventing sufficient adhesion. When applying to a wood frame, the surface must be non-porous and sealed. Follow standard industry guidelines on sealed wood frames and/or rough surface before applying. Note: Anti-bacterial, anti-fungal or silicone additives in paint may inhibit adhesion.

Application tips and warnings:

- Do NOT stretch material. Product can retract or shrink if stretched.
- Use very firm, perpendicular pressure when applying. Use wallpaper seam roller to reinforce adhesion after applying.
- Do not stretch material when using seam roller. Run roller with up and down motions.
- Double check adhesion after 2-3 hours before leaving job overnight.
- If gasket separates from frame, press again with firm pressure in place. If adhesive strip is exposed, airborne dust may impede adhesion. Replacement may be necessary.
- Application at header can be awkward due to overhead condition. Be sure to apply enough pressure.

NOTE: Adhesion takes delayed set. Immediate removal and resetting can be done if error occurs in initial placement. DO NOT reset after one hour. Full set is reached in 24 hours.

HSS2000 dadoed in edge of door under veneer

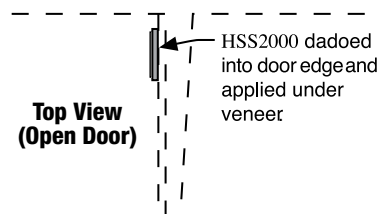

HSS2000 surface applied to door edge at meeting stile

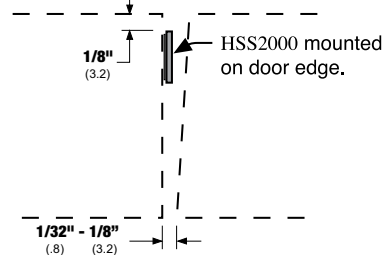

HSS2000 dadoed in edge of the door

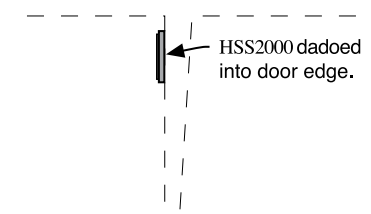

HSS2000 on Frame with Beveled Edge Door

On beveled edges, install HSS2000 (& S44 when required) on jamb at position shown.

HSS2000 mounted on jamb with S44 directly on top.

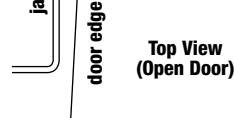

HSS2000 Mounted on the Top Edge of the Door at the Door Jamb Head

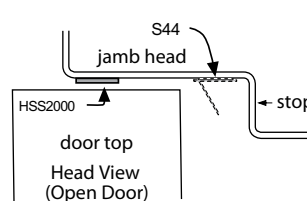

HSS2000 on Frame with Square Edge Door

On square edges, install HSS2000 (& S44, when required) on jamb at positions shown.

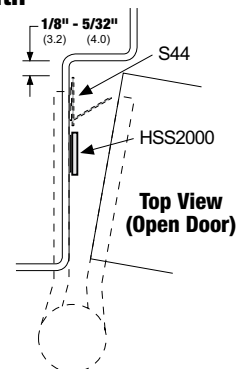

www.pemko.com

© 2010 Pemko Manufacturing Co.
HSS2000_WEBINS
Rev 2 - 11.09.10