

# Major

MANUFACTURING, INC.

## HIT-45 ALUMINUM DOOR SERIES OWNERS MANUAL

INSTALL  
LOCKS  
LATCHES  
LEVERS / PADDLES  
INDICATORS  
FLUSH BOLTS  
STRIKES

*Every Installation  
Is A self-Portrait  
Of The Person Who Did It!  
Autograph  
Your Work With  
Excellence!*

# TABLE OF CONTENTS

	PAGE
GENERAL ROUTER INFORMATION.....	2-4
GENERAL SAFETY INFORMATION.....	5
INSTALLING LOCKS OR LATCHES.....	6-13
INSTALLING LOCK MOUNTING BRACKETS.....	14-18
INSTALLING FLUSH BOLTS.....	19-25
INSTALLING ADAMS RITE 4502/4902 LIP STRIKE.....	26-34
INSTALLING ADAMS RITE 4501/4901 LIP STRIKE.....	35-43
STRIKE CUT OUT FOR ADAMS RITE DEAD BOLT.....	44-50
STRIKE CUT OUT FOR ADAMS RITE HOOK BOLT.....	51-57
HIT-45 DIAGRAM AND PARTS LIST.....	58
WEB SITE INFORMATION.....	59

## ROUTER RECOMMENDATIONS

Thank you for purchasing our HIT-45 modular installation kit. Please take a minute to become familiar with the system and available options.

For aluminum door installation we recommend the use of a commercial router. For operator safety please choose a router that can be switched on/off while both hands always remain on the router handles. We highly recommend a commercial router with a “D” type handle because this router can be more easily controlled and the on/off switch can be operated with your trigger finger. A router that requires you to take one hand off the handle to operate the on/off switch may be difficult to control and possibly dangerous.

D-HANDLE WITH  
ON/OFF  
SWITCH



# **ROUTER and ROUTER BIT RECOMMENDATIONS FOR ALUMINUM DOOR WORK**

**We recommend the use of the Porter Cable model 691 "D" handle router or any "D" handle router of commercial duty. Sears Craftsman and Ryobi routers may be used if equipped with our template guides, the factory does not have the correct sizes.**

**The use of our 1/4" down shear single flute router bit (HIT-45RB4) is also recommended for the following reasons:**

- Standard hardware store bits are usually up shear. This pulls aluminum chips into your router. This may result in damage to your router or possibly clog the template guide causing damage.**
- Standard bits are usually two fluted. This provides less space for the aluminum chips to clear. If too fast a cut is used, the aluminum could weld itself to the bit. Our bits are single flute, they have plenty of room for chip clearance.**
- Carbide bits will cut clean, however they are very brittle and are easily broken in aluminum. With care and proper lubrication, our high speed steel bits will route many openings.**

# ROUTER TEMPLATE GUIDES FOR ALUMINUM DOOR WORK

## ROUTER TEMPLATE GUIDE FOR RYOBI

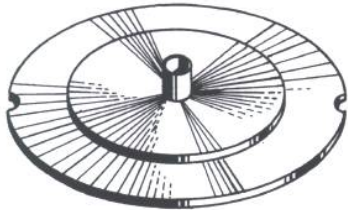

**HIT-45TG2**  
3/8"OD

TEMPLATE GUIDE FOR USE ON RYOBI 160 SERIES ROUTERS WHEN ROUTING ALUMINUM DOORS AND FRAMES. USE A 1/4" DOWN SHEAR ROUTER BIT FOR CUTTING ALUMINUM



**HIT-45RB4**  
1/4" DIA DOWN  
SHEAR ROUTER BIT

## ROUTER TEMPLATE GUIDE FOR SEARS

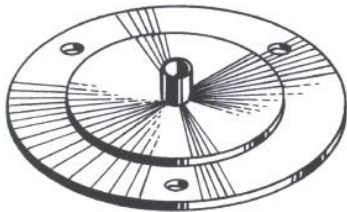

**HIT-45TG1**  
3/8"OD

TEMPLATE GUIDE FOR USE ON SEARS CRAFTSMAN ROUTERS WHEN ROUTING ALUMINUM DOORS AND FRAMES. USE A 1/4" DOWN SHEAR ROUTER BIT FOR CUTTING ALUMINUM.



**HIT-45RB4**  
1/4" DIA DOWN  
SHEAR ROUTER BIT

## ROUTER TEMPLATE GUIDE FOR PORTER CABLE

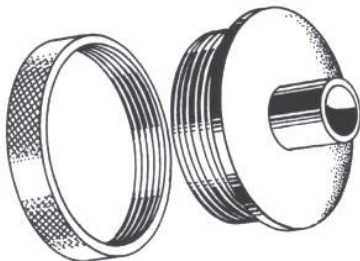

**HIT-45TG5**  
3/8" OD

TEMPLATE GUIDE FOR USE ON PORTER CABLE ROUTERS WHEN ROUTING ALUMINUM DOORS AND FRAMES. USE A 1/4" DOWN SHEAR ROUTER BIT FOR CUTTING ALUMINUM.



**HIT-45RB4**  
1/4" DIA DOWN  
SHEAR ROUTER BIT

**MAKE CERTAIN THAT YOU ARE USING THE  
CORRECT TEMPLATE FOR THE STRIKE BEING  
INSTALLED AND YOUR ROUTER HAS A 3/8”  
OUTSIDE TEMPLATE GUIDE INSTALLED  
IN THE BASE.**

## **GENERAL SAFETY RULES**

**ALWAYS WEAR EYE AND EAR PROTECTION!!**

Before attempting any installation know how to safely use the power tools involved and how they work. Be sure all bits and cutters are sharp and in good condition and all power cords and extension cords are in good working order and properly grounded.

Always make sure the router comes to a **COMPLETE STOP** before pulling it away from the template. Failure to do so may cause damage to your router template, your work or personal injury.

Always route in a **CLOCKWISE** direction. A counterclockwise direction will cause the router bit to climb in the cut and cause an unstable situation.

If you feel you have missed part of the cut, **DO NOT BACK UP!!** You will be making a clean up pass that will take care of the problem.



**INSTRUCTIONS  
FOR  
HIT-45  
MODULAR CLAMP  
FOR ALUMINUM DOOR  
AND MORTISE LOCKS**

**WHEN USING POWER TOOLS  
ALWAYS WEAR  
EYE AND EAR PROTECTION!!**





These are the most important tools that you will use in this installation.

## Always use eye and ear protection!!

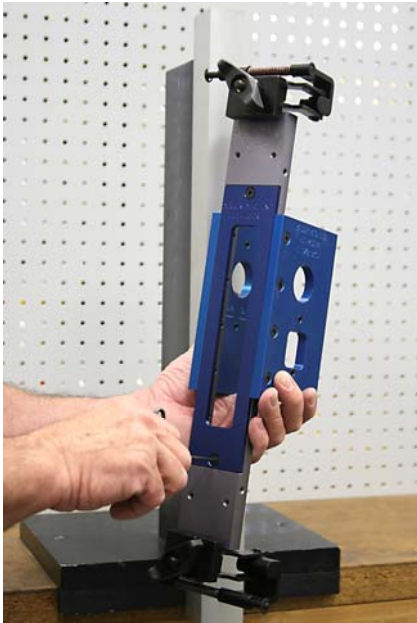

Select the proper template for the backset that you are installing. The most popular backsets, 31/32" and 1-1/8" can be installed with a lock indicator or prepped with a lever/paddle arrangement. Lock templates are fastened to the clamp with 10-32 x 3/4" allen flat head screws. The faceplate template is held on with 10-32 x 1/2" allen flat head screws.

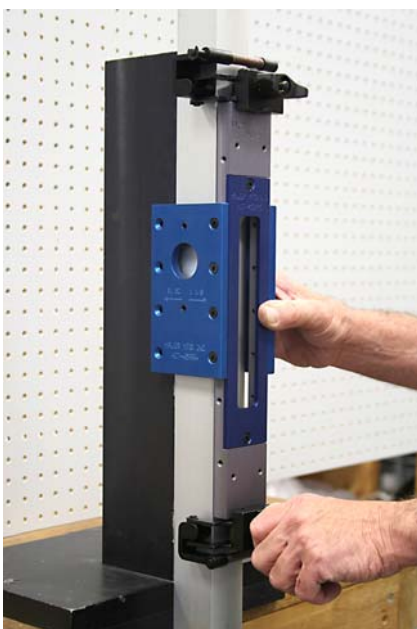

Determine the cylinder height of the lock being installed and secure the HIT-45 clamp and templates onto the door as shown.

If you are installing the new lock above an existing lock, be sure to remove the existing lock or any other hardware in the channel. **FAILURE TO REMOVE EXISTING LOCKS OR HARDWARE FROM THE DOOR CHANNEL WILL RESULT IN FILLING THEM WITH ALUMINUM ROUTING CHIPS AND JAMMING THE MECHANISM !**





Your router needs to be equipped with a 3/8" outside diameter template guide mounted in its base. ***Failure to use a template guide will cause the opening being routed to be too large and may damage your HIT-45 templates or the door.***

Install a 1/4" diameter aluminum router bit into the router collet and secure tightly. Adjust the router bit so it will route about 1/4" to 3/8" into the door channel.



Drill a 3/8" or larger starting hole for the router bit in the center of the template hole to be routed. In the picture we are using a step drill bit.



Drill the same starting holes for the lock cylinder.



Here we are drilling the starter hole for the lock indicator. If you are not using an indicator in your installation, do not drill this hole.



We recommend the area to be routed be lubricated with a cutting lube. We use a product called Tapmatic Edge Cream made by the LPS Company. You can find this product at industrial hardware stores or machine shop supplies. This is also a handy product to use for other drilling or tapping chores.



Place the router bit in the starting hole and with firm control of the router follow the HIT-45 template and feed the router slowly in a **CLOCKWISE DIRECTION**. Make sure the base of the router is held flat on the routing template. We advise routing the cylinder sides of the door first and the faceplate last. When completed with the cut, turn the router off **and wait for the bit to come to a complete stop before removing it from the template. Failure to do so may cause damage to the door, your HIT-45 template or injury to yourself.** After making the first pass, brush away the chips and make a second clean up pass.



Use the same procedure and route the opposite side of the door. Don't forget to brush out the chips and make a second clean up pass.



Route the faceplate opening last. When completed, again brush away the chips and make a second pass. We recommend making this cut last because of the unlikely event of a broken router bit, the large faceplate hole will be covered by the router base and the broken bit will most likely be contained in the channel.

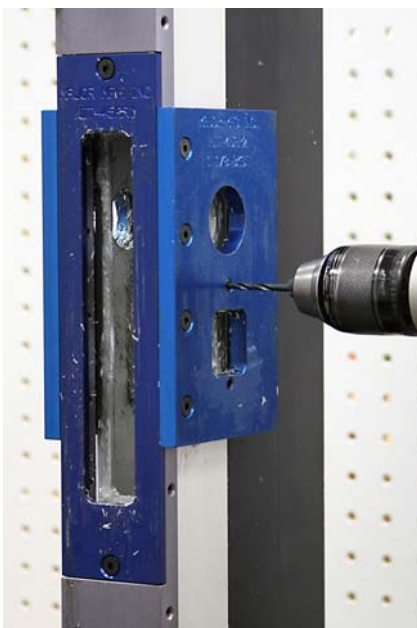

Drill the mounting holes for the indicator with a #21 drill bit.



Clean the area of left over cutting lube and chips. Use a machinist scraper or an aluminum cutting file and deburr all of the openings.



Tap the two indicator mounting holes with a 10-32 tap.



Our LMB-08 mounting brackets and LMB-089 tool are being used to mount the lock in the channel. The door can also be drilled and tapped for lock mounting tabs. We do not advise drilling and tapping the rear of the channel like factory doors. They are drilled and tapped prior to the glass being installed, you will be drilling and tapping into a glass channel. ***You run a great risk of breaking the glass in the door!***





LMB-08 brackets in door and lock going in.



Secure lock with the screws supplied with the mounting bracket.



Install the outside cylinder. We recommend the addition of one of our hardened cylinder guards for security.

***SEE OUR CATALOG OR WEB SITE FOR A COMPLETE LISTING OF CYLINDER GUARDS AND GUARD PLATES.***



Inside thumb turn being installed.



Lock indicator going in, be sure to install per manufacturers directions.



Install the faceplate and the lock is installed.

That's all there is to it!!!



**INSTRUCTIONS  
FOR USE WITH  
LMB-089 TOOL  
INSTALLING  
LMB-08 LOCK BRACKETS  
IN ALUMINUM DOORS**



# INSTRUCTIONS FOR USE WITH **LMB-089** INSTALLATION TOOL FOR LMB-08 BRACKET

## LMB-08 MOUNTING BRACKET AND ADAPTERS

The LMB-08 mounting bracket will conform to three types of door channel. The standard LMB-08 with no adapters is made to fit radius frames. For beveled or flat frames use the supplied adapters as shown. The adapters are mounted on the "ears" of the mounting bracket.

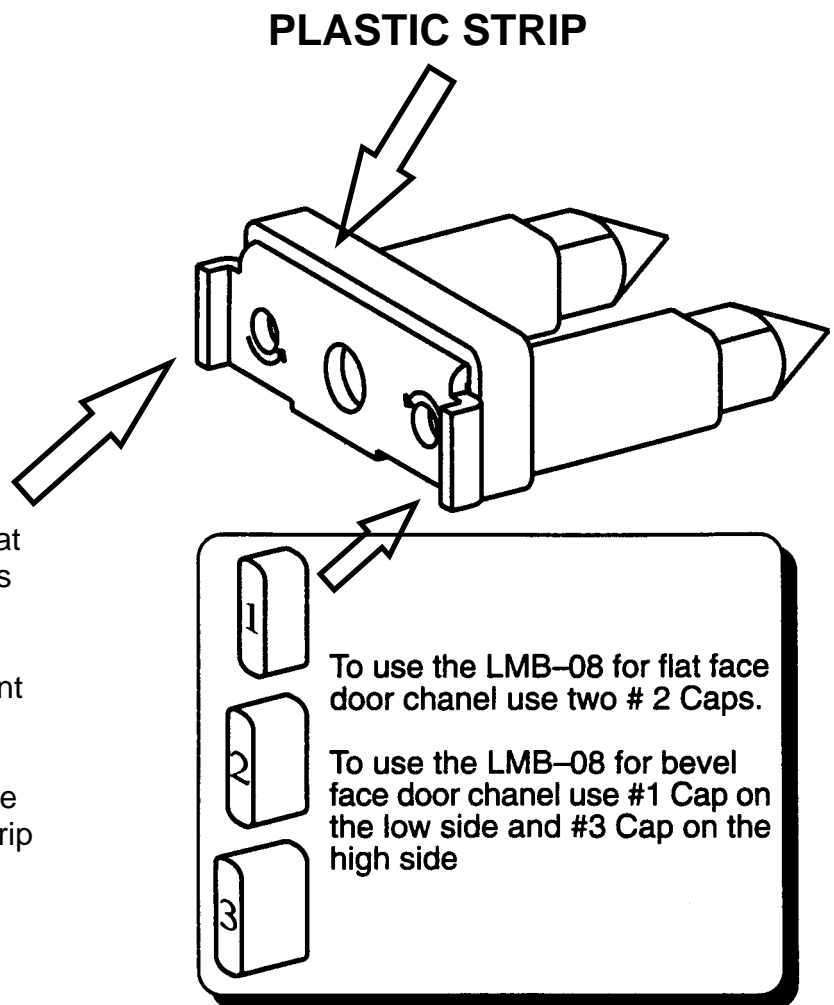

The plastic adapters shown at the right will snap on the ears of the LMB-08 mounting bracket and adapt it to different door types. To mount the adapters properly, make sure that the number on the top of the adapter is right side up when facing the plastic strip on the mounting bracket.



### **LMB-089**

Mounting bracket installation tool.

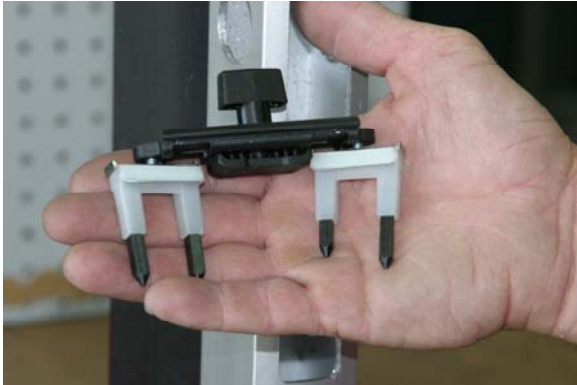

### **ATTACH MOUNTING BRACKETS TO LMB-089 INSTALLATION TOOL**

Using the 8-32 x 1/2" Phillips screws that were supplied, loosely attach a bracket to each side of the tool as shown in the picture. The mounting brackets should be able to spin freely. The knob on the tool should be parallel with the tools length



### **PLACE BRACKETS IN DOOR**

With both brackets attached to the tool and also parallel to the tools length, slide into the door. The mounting bracket has three holes on the top of the plate. One for mounting the lock and two for holding the bracket in the door. One side of the bracket has a plastic strip securing the top plate to the base. Turn one bracket 90 degrees so the plastic strip points away from the tool. Push the knob down and turn 90 degrees, then slide it towards the bracket until it snaps in place. Now slide the entire tool and bracket to one end of the lock cut out until the tool stops.



### SQUARE BRACKETS IN DOOR

Lightly tighten the Phillips mounting screw, this will square the bracket in the door.



### SECURE BRACKETS IN DOOR

With the supplied 7/64" ball tip allen wrench, turn the two allen screws counter clockwise until tight.

**NOTE: OVER TIGHTENING THESE SCREWS WILL DISTORT THE BRACKET.**

Remove the Phillips screw and mount the other bracket in the same manner. Save the screws and use them to mount the lock in the door frame.

First bracket mounted in door.



### MOUNT SECOND BRACKET

Remove the Phillips screw and mount the other bracket in the same manner. Save the screws and use them to mount the lock in the door frame.

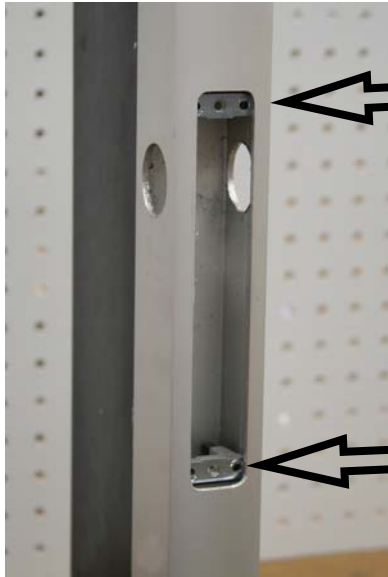

Top mounting bracket—plastic strip is facing **UP**.

### **BOTH MOUNTING BRACKETS INSTALLED**

Both mounting brackets are now installed in door frame. Note position of plastic strip, if brackets are mounted upside down, the hole spacing will be off.

Bottom mounting bracket—plastic strip is facing **DOWN**.



Insert lock in door.



Secure lock in door using screws supplied with brackets. Installation is complete. Add lock cylinders and faceplate.



**INSTRUCTIONS FOR  
INSTALLING  
INTERNATIONAL FB-1202  
FLUSH BOLTS ON ALUMINUM DOORS  
WITH THE HIT-45FB1 TEMPLATE**

**WHEN USING POWER TOOLS  
ALWAYS WEAR  
EYE AND EAR PROTECTION!!**



These are the most important tools that you will use in this installation.

## **Always use eye and ear protection!!**



Your router needs to be equipped with a 3/8" outside diameter template guide mounted in its base. Failure to use a template guide will cause the opening being routed to be too large and will damage your HIT-45 template.

***See our catalog or web site for a list of available router template guides.***

Install a 1/4" diameter aluminum cutting router bit ( our part # HIT-45RB4 ) into the router collet and secure tightly. Adjust the router bit so it will route about through the door channel.

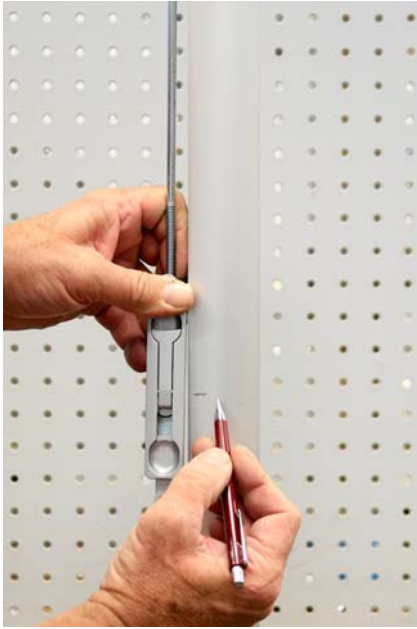

Determine the location of the flush bolt being installed. Make sure you mark the center of the opening and have the bolt in the retracted position so you have enough throw when it is installed.



With the HIT-45FB1 template attached to your HIT-45 clamp, center the template over the center line from the above step.



Drill a 3/8" or larger starting hole for the router bit in the center of the template hole to be routed. In the picture we are using a step drill bit.





We recommend the area to be routed be lubricated with a cutting lube. We use a product called Tapmatic Edge Cream made by the LPS Company. You can find this product at industrial hardware stores or machine shop supplies. This is also a handy product to use for other drilling or tapping chores.



Place the router bit in the starting hole and with firm control of the router follow the HIT-45 template and feed the router slowly in a **CLOCKWISE DIRECTION. DO NOT BACK UP IN THE CUT IF YOU THINK YOU MISSED AN AREA.** Make sure the base of the router is held flat on the routing template. When completed with the cut, turn the router off and wait for the bit to come to a **complete stop before removing it from the template. Failure to do so may cause damage to the door, your HIT-45 template or injury to yourself.** After making the first pass, brush away the chips and make a second clean up pass.



With the Clamp still attached to the door, drill the mounting holes for the flush bolt with a 5/32" drill bit.



Clean the area of left over cutting lube and chips. Use a machinist scraper or an aluminum cutting file and deburr all of the openings.



Counter sink the two mounting holes to fit the screws supplied with the flush bolt.



Completed flush bolt prep.



Mark the location for the guide bracket. You can use the factory supplied plastic guide, or upgrade to our steel bracket (LMB-06 square hole or LMB-07 hex Hole).

After marking the holes center punch for a starting point.



Drill all three marks with a 5/32" drill bit and counter sink for the flat head screws when complete.

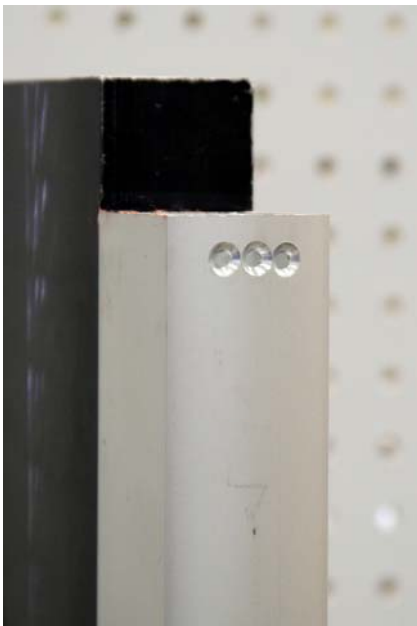

Rod guide holes drilled and counter sunk.



Install flush bolt into opening and secure with the factory supplied screws. Don't forget to adjust rod height prior to installing.

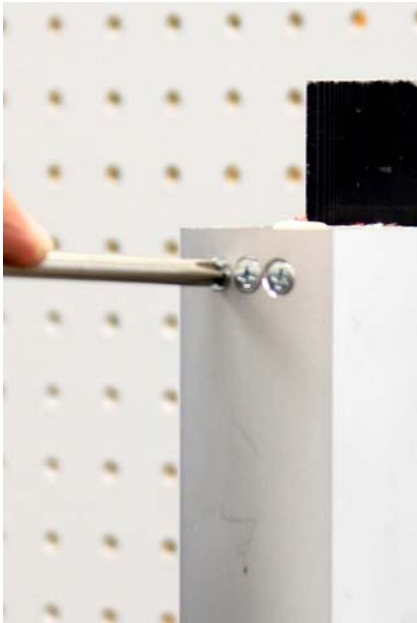

Install rod guide and fasten in place.



There you have it, a completed installation.

That's all there is to it!

The following pages  
show strike  
installations only.

The HIT-45 is  
**NOT** Required

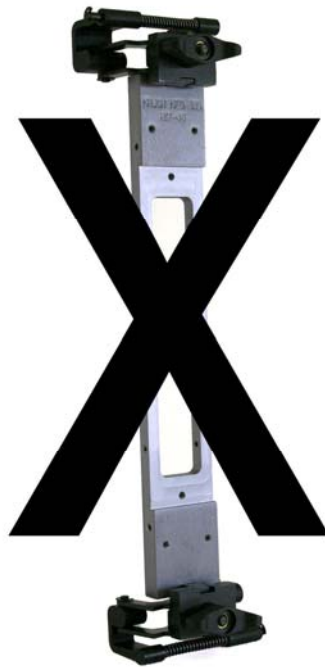



**INSTRUCTIONS  
FOR HIT-40AR3  
ADAMS RITE 4502/4902  
SERIES LIP STRIKE  
TEMPLATE**

**WHEN USING POWER TOOLS  
ALWAYS WEAR  
EYE AND EAR PROTECTION!!**



These are the most important tools that you will use in this installation.

## **Always use eye and ear protection!!**



Your router needs to be equipped with a 3/8" outside diameter template guide mounted in its base. Failure to use a template guide will cause the opening being routed to be too large and will damage your HIT-40 template.

***See our catalog or web site for a list of available router template guides.***

Install a 1/4" diameter aluminum router bit into the router collet and secure tightly. Adjust the router bit so it will route about 1/4" to 3/8" into the door channel.





For height alignment, close the door until the latch makes contact with the door jamb. Use a pencil and mark the top and bottom of the latch.



Use a combination square and transfer the lines on the front edge of the door to the side. This will show the location of the latch when it is in the locked position.



Find the center line of the jamb. This example shows the center line on a 4" wide offset hung door. The center line is  $\frac{7}{8}$ " from the stop, or one half the thickness of the door. Use a combination square and draw a vertical line at this point.



Pencil lines showing the center line of the jamb and the height of the bolt when locked have been established. Use the alignment marks on the template to align with the pencil lines on the jamb. We will route the strike opening with our HIT-40AR3 template. Attach to jamb with the supplied tek point screws and an electric drill. NOTE: It is a good idea that your drill is equipped with a clutch feature, this will prevent snapping the screw off in the jamb.



Make sure the template is square to the jamb prior to running the second screw in.



Template mounted and ready to go.



Drill a 3/8" or larger starting hole for the router bit in the center of the template hole to be routed. In the picture we are using a step drill bit.



We recommend the area to be routed be lubricated with a cutting lube. We use a product called Tapmatic Edge Cream made by the LPS Company. You can find this product at industrial hardware stores or machine shop supplies. This is also a handy product to use for other drilling or tapping chores.



Place the router bit in the center of the starting hole.



Place the router bit in the starting hole and with firm control of the router follow the HIT-40 template and feed the router slowly in a **CLOCKWISE DIRECTION**.

Route in a line up the front portion of the jamb staying just inside the frame to complete the opening. ( If you route out the front of the frame at this point, there will be a large gap in front of the strike that will be visible. ) This area will be routed out after the bit has been adjusted to a new cutting depth.

**IMPORTANT!! DO NOT ROUTE THROUGH THE FRONT EDGE OF THE JAMB. MAKE THE VERTICLE CUT ABOUT 3/8" INSIDE THE FRONT EDGE.**

Make sure the base of the router is held flat on the routing template. When completed with the cut, turn the router off **and wait for the bit to come to a complete stop before removing it from the template. Failure to do so may cause damage to the door, your HIT-40 template, or injury to yourself.**



This is the area you did not cut through in the step above. Adjust the depth of the router to cut the thickness of the jamb material only, this should be a cut depth of only about 1/8 inch. Use the router to nibble away this area.



Remove the router template , clean off the lube and de-burr the sharp edges with scraper or file.



Drill out the holes left by the tek screws to 3/16". These holes will be used to mount the factory mounting bracket.



Counter sink both holes for the 10-32 flat head mounting screws supplied by the factory.





Factory mounting bracket being installed.



Finished installation showing strike and dust box.



That's all there is to it!!



**INSTRUCTIONS  
FOR HIT-40AR4  
ADAMS RITE 4501/4901  
SERIES LIP STRIKE  
TEMPLATE**

**WHEN USING POWER TOOLS  
ALWAYS WEAR  
EYE AND EAR PROTECTION!!**





These are the most important tools that you will use in this installation.

## **Always use eye and ear protection!!**



Your router needs to be equipped with a 3/8" outside diameter template guide mounted in its base. Failure to use a template guide will cause the opening being routed to be too large and will damage your HIT-40 template.

***See our catalog or web site for a list of available router template guides.***

Install a 1/4" diameter aluminum router bit into the router collet and secure tightly. Adjust the router bit so it will route about 1/4" to 3/8" into the door channel.



The Adams Rite 4501/4901 strike plate was designed to fill the opening of a deadbolt lock when retrofitting to a deadlatch style lock.

The strike plate has two openings. Only one will be used depending on the hand of the door, the other will be filled by the black plastic dust cover.





For height alignment, close the door until the latch makes contact with the door jamb. Use a pencil and mark the top and bottom of the latch.

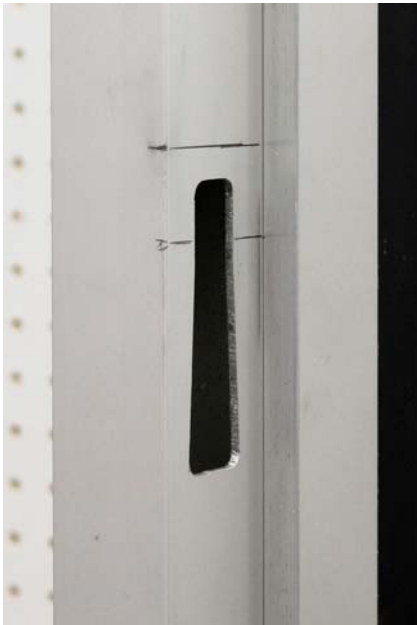

Use a combination square and transfer the lines on the front edge of the door to the side. This will show the location of the latch when it is in the locked position.



Find the center line of the jamb. This example shows the center line on an offset hung door. The center line is  $7/8$ " from the stop, or one half the thickness of the door. Use a combination square and draw a vertical line at this point.



Pencil lines showing the center line of the jamb and the height of the latch when locked have been established. Use the alignment marks on the template to align with the pencil lines on the jamb. Use the two lines on the top of the template. **DO NOT USE THE TWO CENTER LINES.** We will route the strike opening with our HIT-40AR4 template. Attach to jamb with the supplied tek point screws and an electric drill. NOTE: It is a good idea that your drill is equipped with a clutch feature, this will prevent snapping the screw off in the jamb.



Make sure the template is square to the jamb prior to running the second screw in.



Template mounted and ready to go. We recommend the area to be routed be lubricated with a cutting lube. We use a product called Tapmatic Edge Cream made by the LPS Company. You can find this product at industrial hardware stores or machine shop supplies. This is also a handy product to use for other drilling or tapping chores.



You are now ready to route the new opening.

Place the router bit in the existing cut out and with firm control of the router follow the HIT-40 template and feed the router slowly in a **CLOCKWISE DIRECTION**.



Route in a line up the front portion of the jamb staying just inside the frame to complete the opening. ( If you route out the front of the frame at this point, there will be a large gap in front of the strike that will be visible. ) This area will be routed out after the bit has been adjusted to a new cutting depth.

**IMPORTANT!! DO NOT ROUTE THROUGH THE FRONT EDGE OF THE JAMB. MAKE THE VERTICLE CUT ABOUT 3/8" INSIDE THE FRONT EDGE.**

Make sure the base of the router is held flat on the routing template. When completed with the cut, turn the router off **and wait for the bit to come to a complete stop before removing it from the template. Failure to do so may cause damage to the door, your HIT-40 template, or injury to yourself.**





This is the area you did not cut through in the step above. Adjust the depth of the router to cut the thickness of the jamb material only, this should be a cut depth of only about 1/8 inch. Use the router to nibble away this area.



Remove the router template , clean off the lube and de-burr the sharp edges with a scraper or a file.



Drill out the holes left by the tek screws to 3/16". These holes will be used to mount the factory mounting bracket.



Counter sink the top and bottom holes for 10-32 flat head screws.



Mounting bracket inside opening and first screw being installed.



Factory bracket installed.





Black plastic dust box installed in mounting bracket.



Install strike plate using factory supplied 10-32 flat head screws.



Completed installation.

That's all there is to it!



**INSTRUCTIONS  
FOR  
HIT-40AR5  
STRIKE TEMPLATE  
FOR AR DEAD BOLT**

**WHEN USING POWER TOOLS  
ALWAYS WEAR  
EYE AND EAR PROTECTION!!**



These are the most important tools that you will use in this installation.

## **Always use eye and ear protection!!**



Your router needs to be equipped with a 3/8" outside diameter template guide mounted in its base. Failure to use a template guide will cause the opening being routed to be too large and will damage your HIT-40 template.

***See our catalog or web site for a list of available router template guides.***

Install a 1/4" diameter aluminum router bit into the router collet and secure tightly. Adjust the router bit so it will route about 1/4" to 3/8" into the door channel.



For height alignment, throw the bolt and close the door until it makes contact with the door jamb. Use a pencil and mark the top and bottom of the bolt.



Use a combination square and transfer the lines on the front edge of the door to the side. This will show the location of the bolt when it is in the locked position.

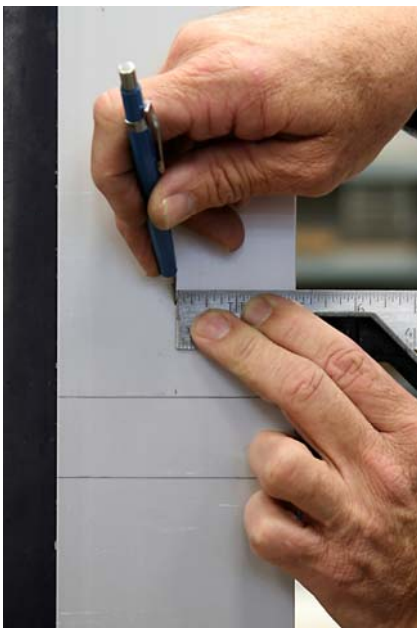

Find the center line of the jamb. This example shows the center line on a 4" wide center hung door. The center line is 2". Use a combination square and draw a vertical line at this point. Note: The center line on an offset hung door will be half the distance from the door stop to the outside of the jamb.



Pencil lines showing the center line of the jamb and the height of the bolt when locked have been established.



We will route the strike opening with our HIT-40AR5 template. Use the alignment marks on the template to align with the pencil lines on the jamb. Attach to jamb with the supplied tek point screws and an electric drill. Make sure the template is square to the jamb prior to running the second screw in.

NOTE: It is a good idea that your drill is equipped with a clutch feature, this will prevent snapping the screw off in the jamb.



Template mounted and ready to go.



Drill a 3/8" or larger starting hole for the router bit in the center of the template hole to be routed. In the picture we are using a step drill bit.



We recommend the area to be routed be lubricated with a cutting lube. We use a product called Tapmatic Edge Cream made by the LPS Company. You can find this product at industrial hardware stores or machine shop supplies. This is also a handy product to use for other drilling or tapping chores.



Place the router bit in the center of the starting hole.





Place the router bit in the starting hole and with firm control of the router follow the HIT-40 template and feed the router slowly in a **CLOCKWISE DIRECTION**. Make sure the base of the router is held flat on the routing template. When completed with the cut, turn the router off **and wait for the bit to come to a complete stop before removing it from the template. Failure to do so may cause damage to the door, your HIT-40 template or injury to yourself.** After making the first pass, brush away the chips and make a second clean up pass.



Clean the area of left over cutting lube and chips. Use a machinist scraper or an aluminum cutting file and deburr all of the openings.

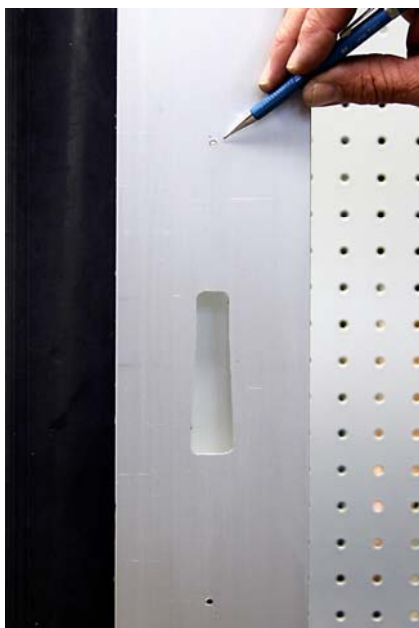

The two small template mounting holes left by the tek screws can be left as is. Or can be drilled out to 1/8" and filled with a steel pop rivet.





Installing a pop rivet.



Finished installation showing mounting holes filled with a pop rivet.

That's all there is to it!!



**INSTRUCTIONS  
FOR  
HIT-40AR6  
STRIKE TEMPLATE  
FOR AR HOOK BOLT**

**WHEN USING POWER TOOLS  
ALWAYS WEAR  
EYE AND EAR PROTECTION!!**



These are the most important tools that you will use in this installation.

## **Always use eye and ear protection!!**



Your router needs to be equipped with a 3/8" outside diameter template guide mounted in its base. Failure to use a template guide will cause the opening being routed to be too large and will damage your HIT-40 template.

***See our catalog or web site for a list of available router template guides.***

Install a 1/4" diameter aluminum router bit into the router collet and secure tightly. Adjust the router bit so it will route about 1/4" to 3/8" into the door channel.



For height alignment, throw the bolt and close the door until it makes contact with the door jamb. Use a pencil and mark the top and bottom of the hook bolt. Mark the hook area of the bolt as shown.



Use a combination square and transfer the lines on the front edge of the door to the side. This will show the location of the bolt when it is in the locked position.



Find the center line of the jamb. This example shows the center line on a 4" wide center hung door. The center line is 2". Use a combination square and draw a vertical line at this point. Note: The center line on an offset hung door will be half the distance from the door stop to the outside of the jamb.



Pencil lines showing the center line of the jamb and the height of the bolt when locked have been established.



We will route the strike opening with our HIT-40AR6 template. Use the alignment marks on the template to align with the pencil lines on the jamb. Attach to jamb with the supplied tek point screws and an electric drill. Make sure the template is square to the jamb prior to running the second screw in.

NOTE: It is a good idea that your drill is equipped with a clutch feature, this will prevent snapping the screw off in the jamb.

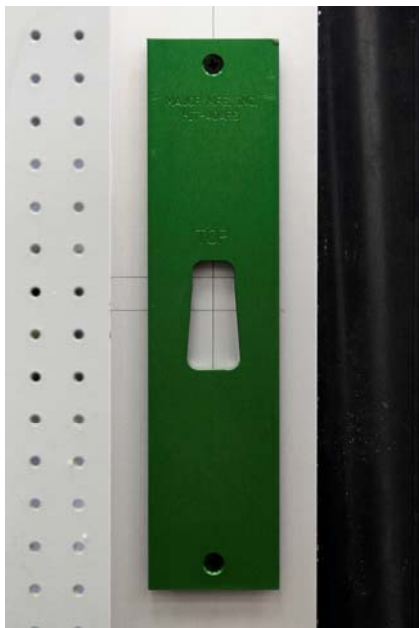

Template mounted and ready to go.



Drill a 3/8" or larger starting hole for the router bit in the center of the template hole to be routed. In the picture we are using a step drill bit.



We recommend the area to be routed be lubricated with a cutting lube. We use a product called Tapmatic Edge Cream made by the LPS Company. You can find this product at industrial hardware stores or machine shop supplies. This is also a handy product to use for other drilling or tapping chores.



Place the router bit in the center of the starting hole.





Place the router bit in the starting hole and with firm control of the router follow the HIT-40 template and feed the router slowly in a **CLOCKWISE DIRECTION**. Make sure the base of the router is held flat on the routing template. When completed with the cut, turn the router off **and wait for the bit to come to a complete stop before removing it from the template. Failure to do so may cause damage to the door, your HIT-40 template or injury to yourself.** After making the first pass, brush away the chips and make a second clean up pass.



Clean the area of left over cutting lube and chips. Use a machinist scraper or an aluminum cutting file and deburr all of the openings.



The two small template mounting holes left by the tek screws can be left as is. Or can be drilled out to 1/8" and filled with a steel pop rivet.



Installing a pop rivet.



Finished installation showing mounting holes filled with a pop rivet.

That's all there is to it!

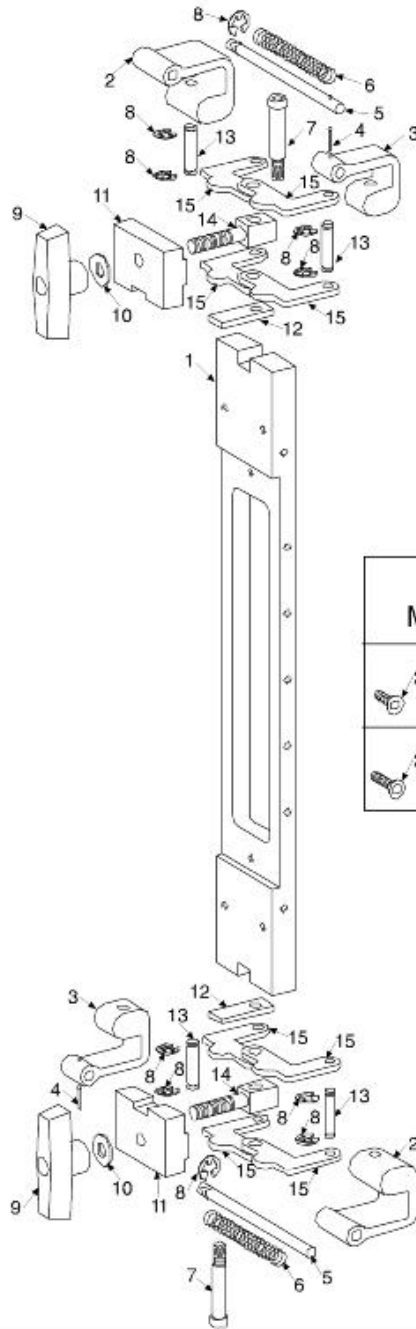

TEMPLATE MOUNTING SCREWS	
25	4535 Flat Head Screw, 1/2" long
26	4536 Flat Head Screw, 3/4" long

ITEM	PART NO.	DESCRIPTION	ITEM	PART NO.	DESCRIPTION	ITEM	PART NO.	DESCRIPTION
1	4501	Base	10	4515	Bearing Washer	24	4508	Button Head Screw
2	4528	R.H. Foot Bracket	11	4507	Block	25	4535	Flat Head Screw, 1/2" long
3	4529	L.H. Foot Bracket	12	4523	Support Locator	26	4536	Flat Head Screw, 3/4" long
4	4531	Roll Pin	13	4505	Clamp Pin			
5	4530	Shaft	14	4514	Stud Locator			
6	4532	Compression Spring	15	4506	Clamp			
7	4533	Shoulder Bolt	20	4511	Alignment Plate SC			
8	4504	E-Ring	22	4509	Locator SC			
9	4534	Knob	23	4526	Locator Stud			

**Major**  
MANUFACTURING, INC.

• (714) 772-5202 • FAX (714) 772-2302

**Visit our web site at:**

**[www.majormfg.com](http://www.majormfg.com)**

**for more information or router recommendations, template guides and other templates to make your installations easier and faster. While there sign up for our newsletter and we will email new product information directly to you.**