



5800 Series

Cast Iron Door Closers

introduction

Yale® 5800 series cast iron door closers are ideal for commercial applications where ease of use, installation and aesthetics are required at an economical price.

The 5800 series features rugged construction, adjustments for backcheck, closing and latch speed, rack and pinion operation and a variety of arm options.

features

- Adjustable spring sizes 1 through 6
- Non-handed
- Cast iron
- Tri-packed: regular, parallel or top jamb mounting
- Adjustable backcheck valve
- Adjustable closing speed valve
- Adjustable latching speed valve
- Full plastic cover
- Spring power adjustment
- Hold-open and heavy-duty arms arm configurations
- Sleeve nuts included with all models

certifications

- Certified for ANSI/BHMA A156.4 Grade 1
- UL and cUL listed. This includes compliance to UL10C.
- Meets requirements for Americans with Disabilities Act (ADA) and ANSI/BHMA A117.1
- 10-year limited warranty

door closing latching cycle

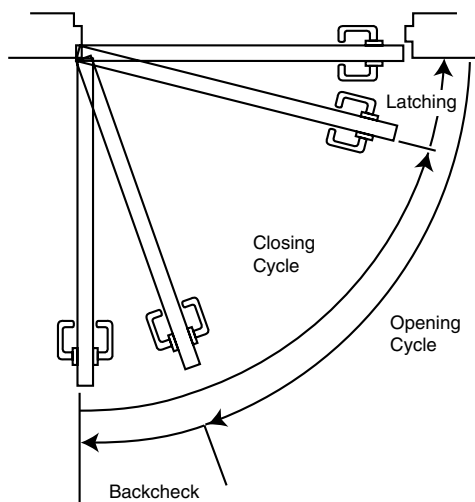

contents

Introduction	2
Features	2
Certifications	2
Door Closing Latching Cycle	2
Finishes	2
Applications	3
Parts/Accessories	4
How To Order	5

finishes

ANSI/BHMA Code	Finish Description
689	Aluminum Painted
690	Dark Bronze Painted

arms

Non-Hold Open

Self-closes door every time door is opened. Auxiliary stop (by others) required except when using the Holder/Stop arm.

Hold Open

Achieved by means of friction or ball and detent/ roller. Friction hold open has a range of 90° to 180° using template location and mechanical adjustment. Ball and detent or roller hold open is effective in a range of 85° to 110°.

Hold open arm door closers are not permitted to be used on fire door assemblies.

applications

regular arm

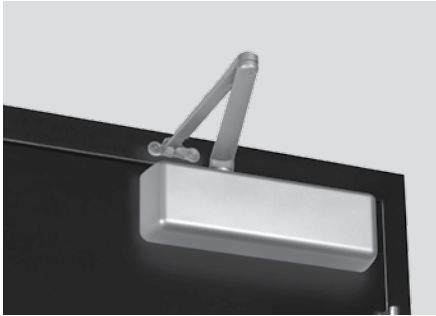

Non-hold open arm shown, hold open application available.

This is the only pull side application where a double lever arm is used. It is the most power-efficient application for a door closer. Sufficient frame, door and/or ceiling clearance must be considered. Since the arm assembly projects directly out from the frame, this application may present an aesthetics issue or be prone to vandalism.

top jamb

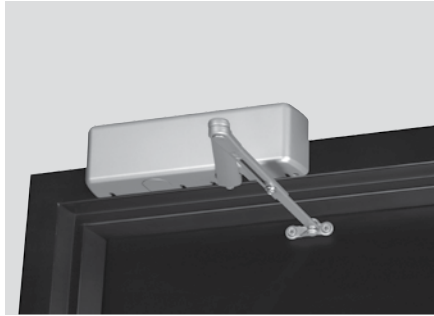

Non-hold open arm shown, hold open application available.

For efficiency reasons this application provides the best alternative to the regular arm application. There must be sufficient frame face and/or ceiling clearance for this application. It requires a top rail on the door of just 2-1/4" (57mm). This application provides the best door control for doors in exterior walls that swing out of a building. The entire door closer and arm assembly project from the frame, similar to the regular arm application, where matters of appearance and malicious abuse can be of concern. Consideration must be given to depth of reveal.

parallel arm

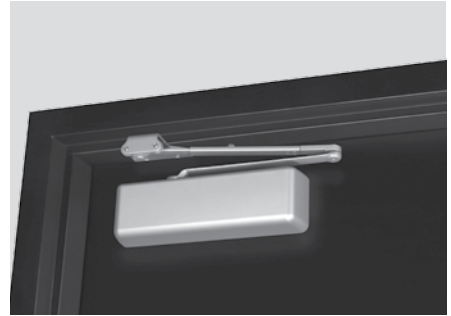

Non-hold open arm shown, hold open application available.

This application provides the most appealing design appearance for a surface-mounted door closer having a double lever arm. This also makes it beneficial in vandalism-prone areas. It is on the push side of the door and the arm assembly extends almost parallel to the door. In the closed position, there is very little or no hardware projecting beyond the frame face in most situations. Due to the geometry of the arm it is approximately 25% less power-efficient than a regular arm application. The entire closer and arm assembly are mounted below the frame stop. Top rail clearance dimensions will vary based on the type of cover used.

holder/stop arm



Hold open arm shown with thumbturn and removable stop

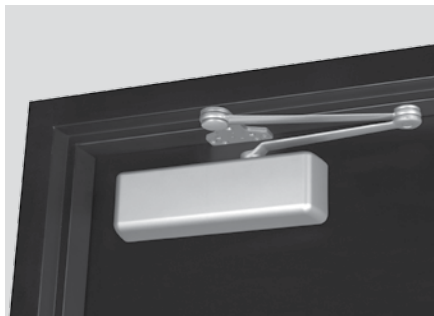

Non-hold open arm shown without stop

This arm incorporates a stop at the arm's soffit plate to dead stop the door at a predetermined degree of door swing between 85° and 110°, in 5° increments. Prior to dead stop the door closer's backcheck feature slows the door speed to reduce the impact of the stop action.

The Holder/Stop arm is intended for use where an auxiliary door stop cannot be utilized and no more than moderate abuse is anticipated. Available with or without hold open. (Hold open strength is adjustable.)

The stop is removable to allow for additional applications where auxiliary door stops are installed.



model/part numbers

Complete Units	
Model Number	Description
5801	Non-Hold Open Tri-Packed, Adjustable Size 1-6
5811	Hold Open Tri-Packed, Adjustable Size 1-6
5821	Heavy-Duty Non-Hold Open Parallel Arm with Removable Stop, Adjustable Size 1-6
5821T	Heavy-Duty Hold Open Parallel Arm with Thumbturn and Removable Stop, Adjustable Size 1-6

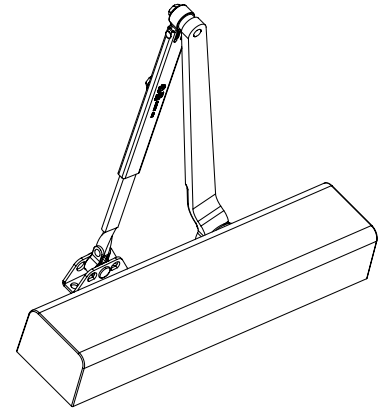

Note: for heavy-duty parallel rigid arm applications, specify 5821 or 5821T, stop is removable.

See page 5 for more how to order info.

Miscellaneous Parts*	
Part Number	Description
5800COV	Full Plastic Cover
5800SP	Screw pack

*Specify finish when ordering.

Optional Fasteners	
Part Number	Description
SN-134	Sleeve Nuts
TBGN134-47	Through-Bolts & Grommet Nuts

Note: Sleeve nuts furnished standard with all models.

Cover Dimensions		
Width	Length	Projection
3-1/2" (89mm)	12-1/4" (311mm)	2-1/4" (57mm)

accessories

closer mounting plates

	<p>5800RDP Narrow Frame Drop Plate (regular arm): Required for hinge side mount where top rail is less than 3-3/4" (95mm). Plate requires 2" (51mm) minimum top rail.</p>
	<p>5800PDP Narrow Top Rail Drop Plate (parallel arm): Required for parallel arm mounting where top rail is less than 5-1/2" (140mm), measured from the stop. Plate requires 2" (51mm) minimum top rail.</p>

Note: All measurements are Inches/mm.

how to order

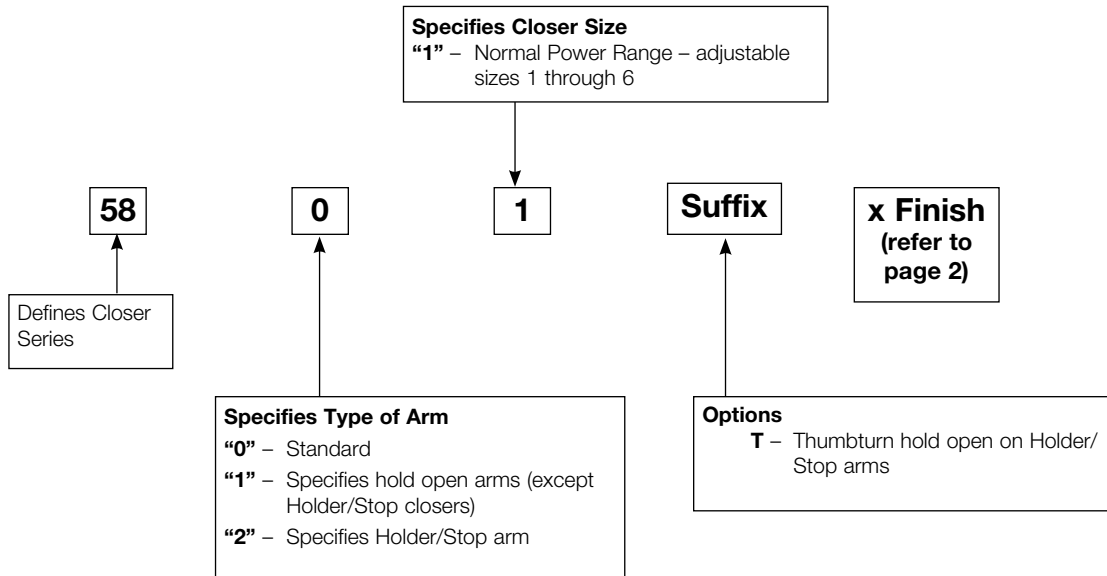

Notes:

- For heavy-duty parallel rigid arm applications, specify 5821 or 5821T, stop is removable.
- Warranty becomes void if door closer is installed on the exterior side of a door in the exterior wall of a building.
- It is strongly recommended, and required on fire door assemblies, that doors having a door closer be hung on ball bearing or anti-friction hinges or pivots; unless an alternate method is identified in the door manufacturer's listing.
- Failure to use the correct type and size fasteners may void factory warranty.
- Fasteners for fire/smoke door assemblies must conform to NFPA 80. In some applications additional fasteners may be mandated by NFPA 80 that are not shipped with standard Yale® product, such as sleeve-nuts/ sex-nuts or through-bolts and grommet nuts.
- Contact factory if door weight exceeds 250 lbs.



online literature and templates

For the latest information on Yale Locks & Hardware products, visit our website at: www.yalelocks.com

Click on the “Product Information” button to find:

- Catalogs
- Parts manuals
- Templates
- Specifications
- Installation instructions

Yale® customers can click on the ebusiness symbol  on the website to register for an ebusiness account to:

- Check the status of orders
- Check availability of QuickShip items
- Track your order and confirm delivery
- Receive email notification of template changes
And More...

Or contact us at:

U.S.A.

Yale Locks & Hardware

Address: 225 Episcopal Road, Berlin, CT 06037-4004
Tel: 1-800-438-1951 • Fax: 1-800-338-0965 • www.yalelocks.com

Canada:

ASSA ABLOY Door Security Solutions Canada

Address: 160 Four Valley Drive, Vaughan, Ontario L4K 4T9
Tel: 1-800-461-3007 • Fax: 1-800-461-8989 • www.assaabloy.ca

International:

ASSA ABLOY Americas International

Tel: 1-905-821-7775 • Fax: 1-905-821-1429 • www.assaabloyai.com

Yale Locks & Hardware is a division of Yale Security Inc., an ASSA ABLOY Group company.

Yale® is a registered trademark of Yale Security Inc., an ASSA ABLOY Group company. Other products' brand names may be trademarks or registered trademarks of their respective owners and are mentioned for reference purposes only. These materials are protected under U.S. copyright laws. All contents current at time of publication. Yale Security Inc. reserves the right to change availability of any item in this catalog, its design, construction, and/or its materials. Copyright © 2012, 2013, Yale Security Inc., an ASSA ABLOY Group company. All rights reserved. Reproduction in whole or in part without the express written permission of the Yale Security Inc., an ASSA ABLOY Group company, is prohibited.

YALE, with its unique global reach and range of products, is the world's favorite lock.

ASSA ABLOY is the global leader in door opening solutions, dedicated to satisfying end-user needs for security, safety and convenience.

42835-6/13R